

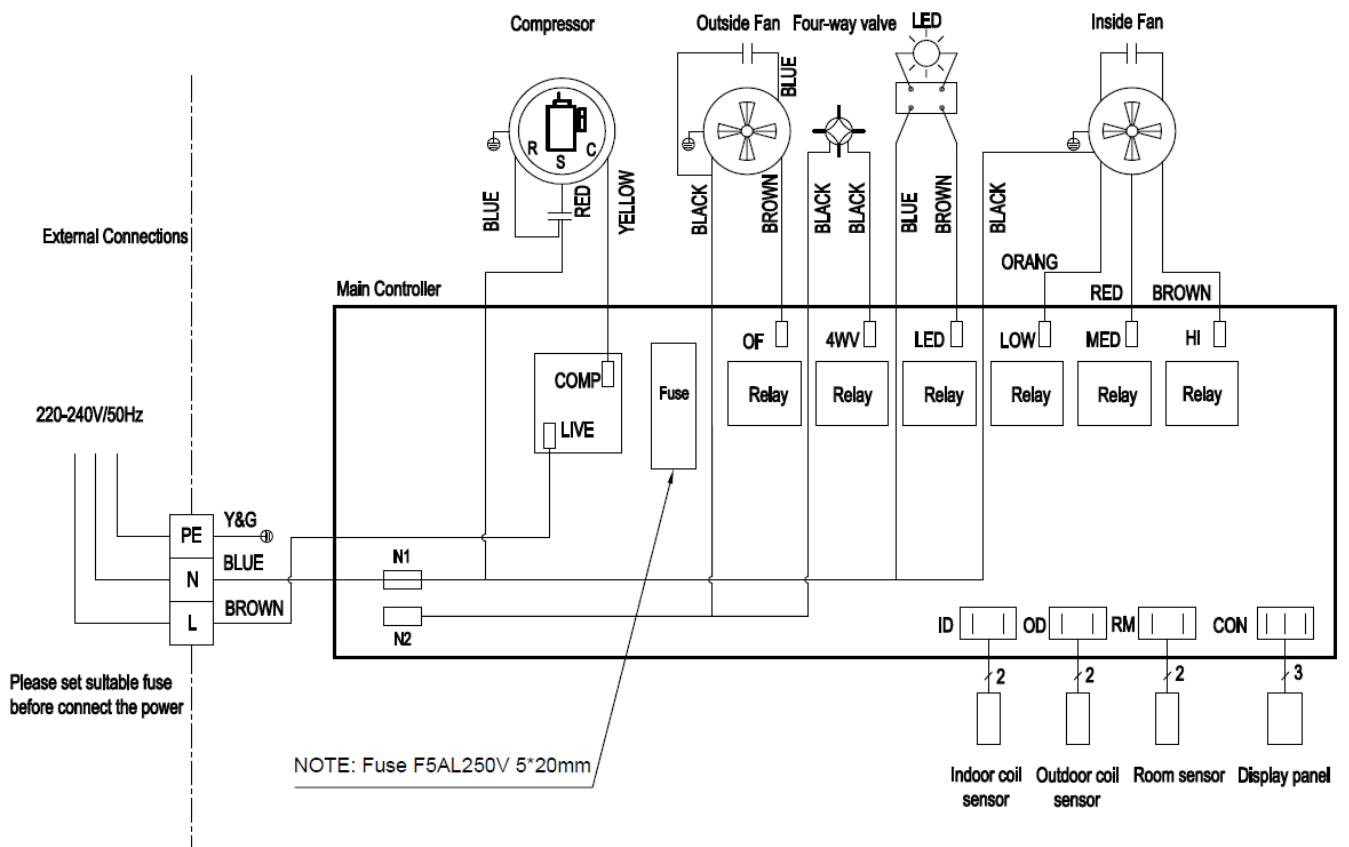

- 
- 1. Introduction**
  - 2. Installation guide**
  - 3. Operation instructions**
  - 4. Specification parameters**
  - 5. Product maintenance**
  - 6. Troubleshooting guide**
  - 7. Warranty**

# Introduction

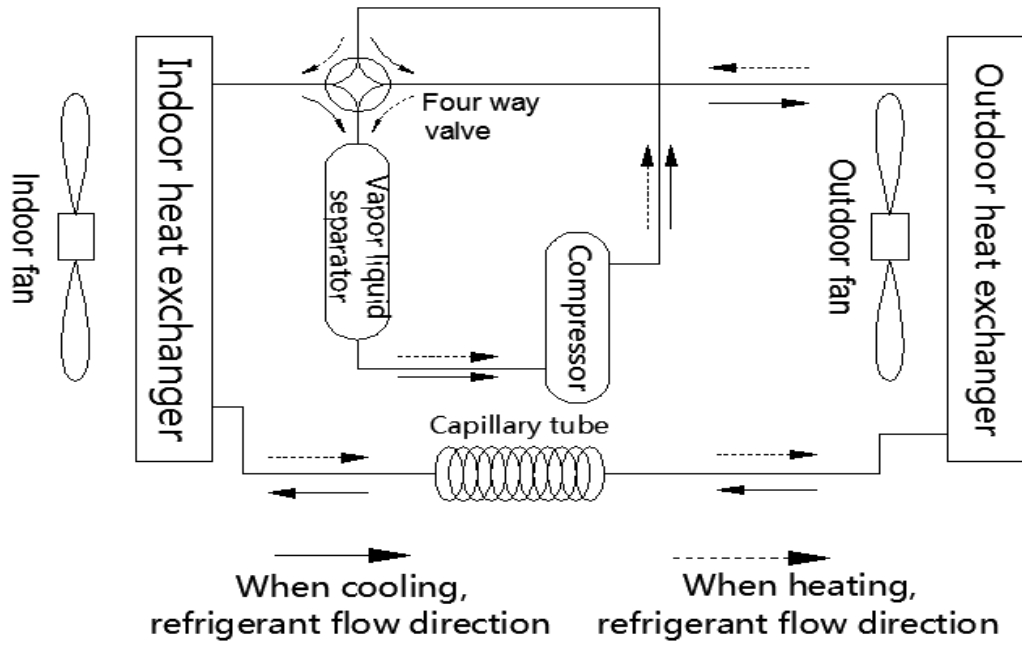

# Introduction

## Exploded Parts List

### Key components:

1. Air-conditioner main unit ×1
2. Reinforced roof support ×1
3. Mounting frame ×1
4. Plenum unit ×1

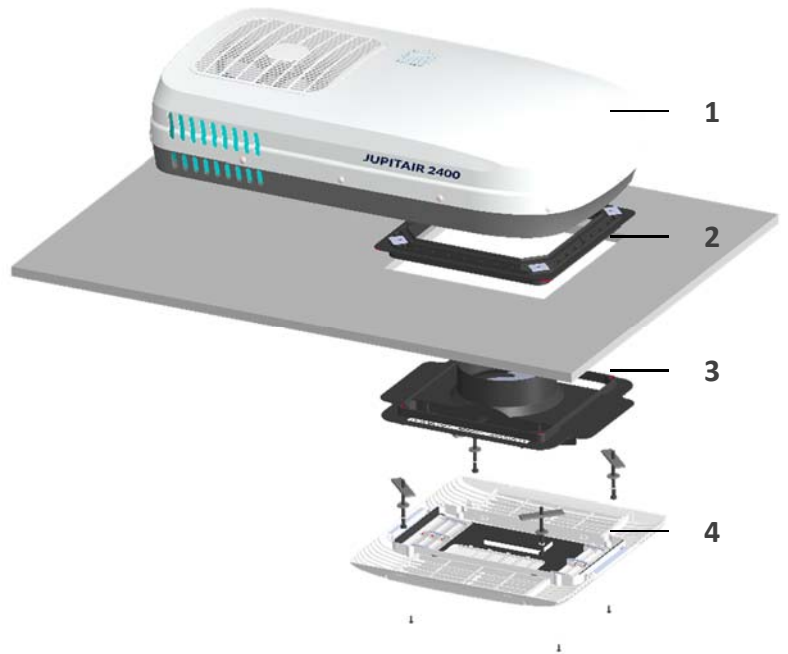

### Fastener components:

5. M8 x 110 mm bolts ×4
6. Fixing washers ×4
7. Round washers ×4
8. Spring washers x4
9. Screws for plenum ×4



5



6



7



8



9

# Introduction

## 1. Operations

The Jupitair 2400-50 creates a comfortable environment for a recreational vehicle or caravan.

It is recommended the user should consult caravan manufacturer to understand total heat-load, as well to choose a suitable air-conditioner, some tips to reduce heat-load and improve performance:



Park the caravan at a shaded place to avoid direct sunshine exposure, close all the doors, skylights and windows, draw the curtains and open the sunshade.



Turn off any unnecessary electrical appliances to reduce the heat-load.



Turn on the air-conditioner in advance if exceptionally high temperatures are expected.



Set suitable temperature by remote control to avoid frequent start and stop.

# Introduction

## 2. Condensation

Condensation usually happens in areas where the air humidity is comparatively high and when warm moist air within the caravan meets with the cold air from the outlet. In this case, please pay attention to the following measures:



Close all the doors, skylights, windows and draw the curtains to decrease any warm moist air from entering.



In the operation of the air-conditioner, condensate (water) will be produced on the roof. Please select *High Fan mode* to increase circulation to decrease condensation degree.

Please note that damage caused by the condensate water is not covered by warranty.

# Introduction

## 3. Choosing 230V power and using generator

The Jupitair 2400-50 requires a stable 230V AC power source, and may require a generator in some remote circumstance.

Requirements for inverter generator include: efficient power source; stable current; output sine wave, which shall meet the requirements of the compressor. The user should consult with the generator supplier for their recommendations.

Please note that damage caused by using a generator is not covered by warranty.

# Installation guide

## Installation requirements

- The RV or caravan roof and cutout needs to be able to support the air-conditioners weight (30kg).
- Minimum thickness of roof:  $\geq 23\text{mm}$ ; maximum thickness of roof:  $\leq 55\text{mm}$ .

## Installation instructions

- Read and understand this manual thoroughly before installation
- Abide by the wiring rules in the installation.
- Do not add other parts or restructure the product during the installation.
- The installers shall be qualified refrigeration technicians
- Consult with dealer in the case of unusual applications or installation conditions that are not specifically covered by this manual.



# Installation guide

## Preparation

- The main unit should be installed in the center of roof, it is recommended to have a min 100mm space around the top unit
- Before installing please verify there is suitable space in the ceiling to accept the plenum
- The installation position (400x400mm) should avoid skylight, solar panels, roof vents, heaters, lights and all electrical connections

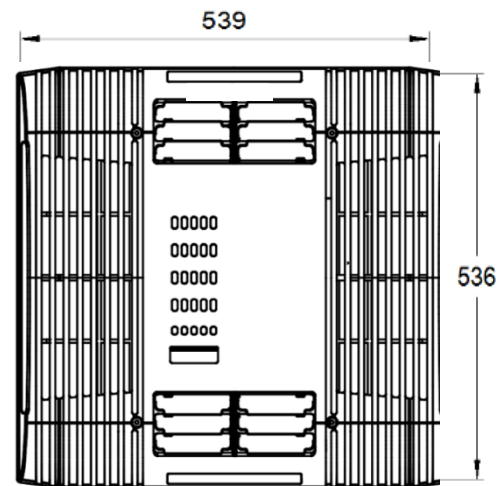
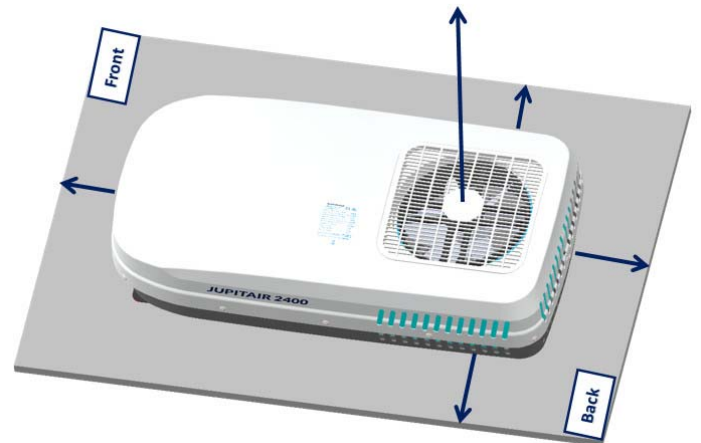
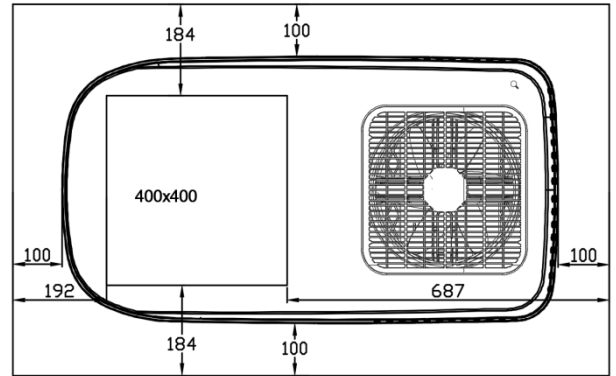

# Installation guide

## Preparation (continued)

- Please check with your caravan manufacturer to confirm the roof can bear the weight of the air-conditioner and maintain a level surface to avoid accumulating condensate/water
- Please consult with your caravan manufacturer for the best solution if there is a requirement to cut a mounting hole if provision has not been made for an air conditioner
- Cut a 400 x 400 hole and reinforce with the appropriate sized timber frame (see pic). This is to ensure the roof will not crush on installation and air does not enter the ceiling space
- In some instances a separate metal frame may be required to reinforce the roof structure. Consult with your caravan manufacturer/installer to reach a suitable solution.

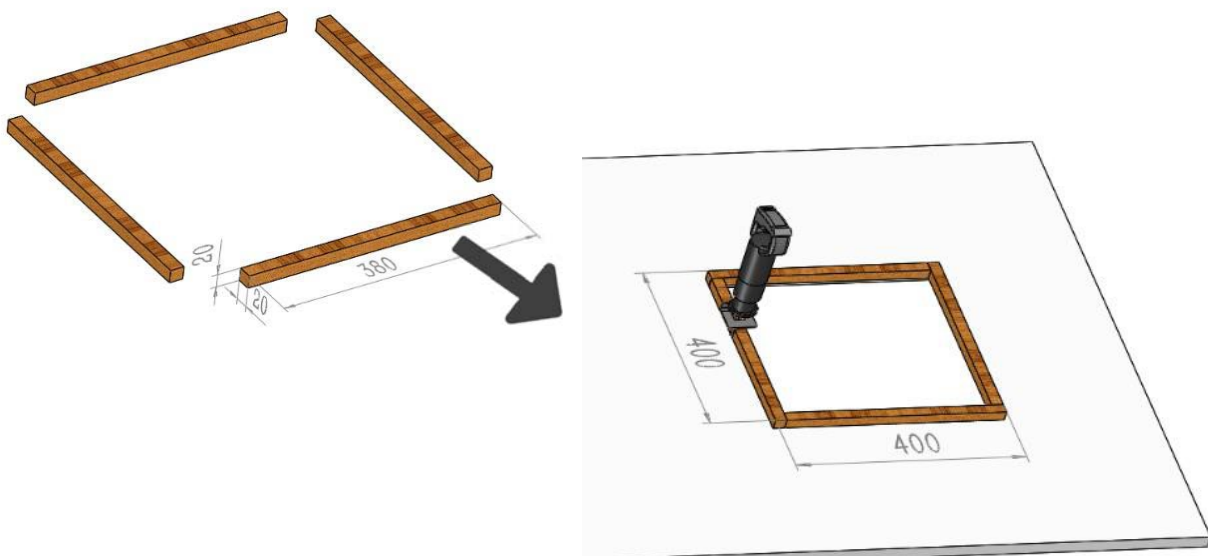

# Installation guide

## Installation

- Remove the roof support from carton and make sure it is aligned correctly.
- Add a continuous line of sealant on the back of the support and fit into the cut out ensuring that it is aligned correctly.
- Install main unit carefully on roof support.

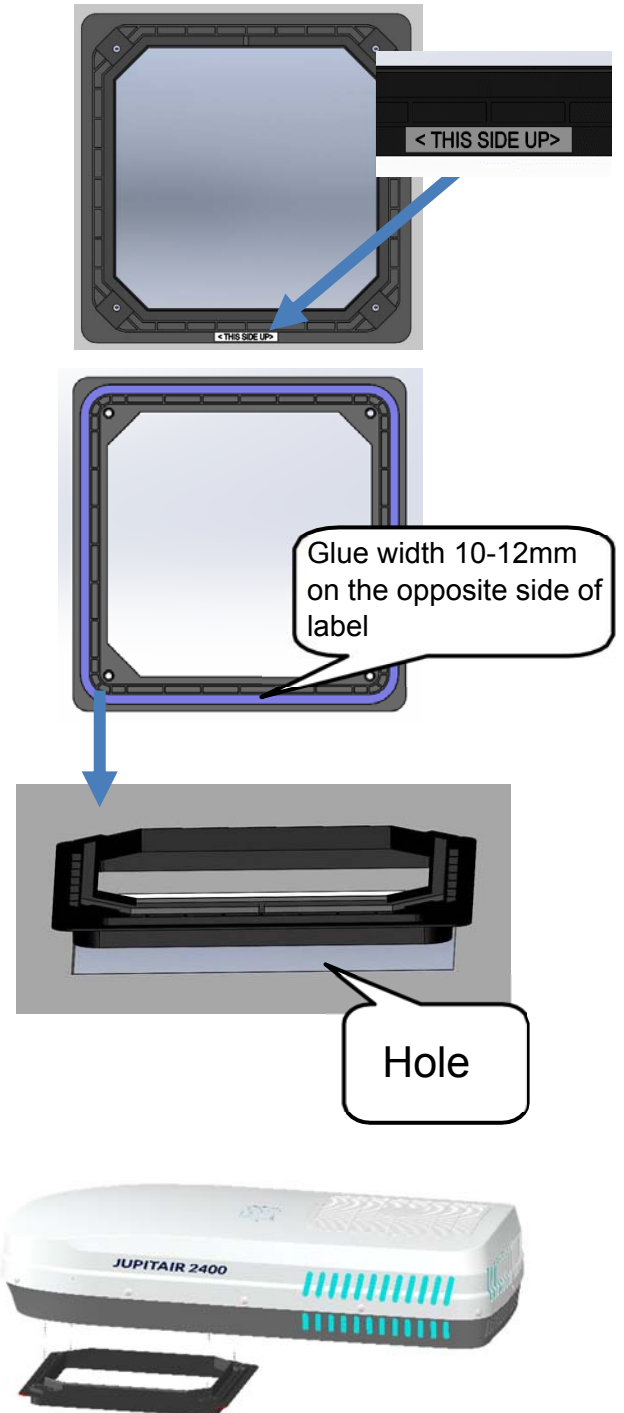

# Installation guide

## Installation (continued)

- Match the corresponding active (brown), neutral (blue) and ground wire (yellow-green) and tighten up screws to make sure power is properly connected.
- Insert plenum mounting bracket through the ceiling to base. Pay attention to mount bracket to correct direction according to label indication. Finally fasten.
- Insert 4xM8 bolts, washers, spring washer and metal plate via mounting frame to the base.

Important: ensure the tightening torque from 12 to 14 N.m

- Plug the connectors on the plenum to the base.

Push plenum into outlet duct and fasten 4xM4 screw on the bottom. Finally add the filters to the sides of the plenum.

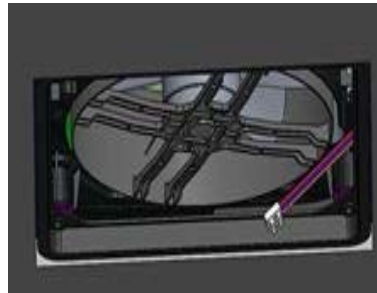

Label not visible from this side

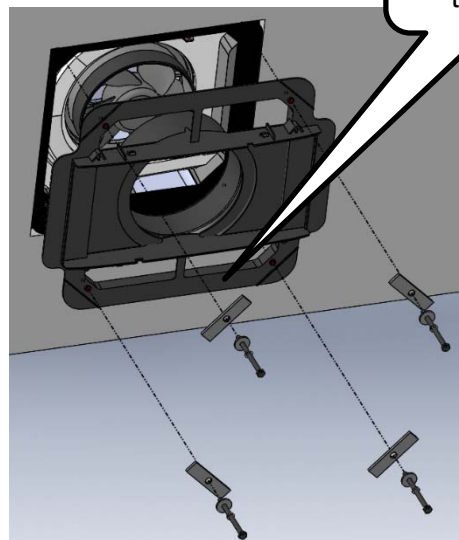

# Operation instruction

## Tips

1. Be careful when installing the unit on the roof of the caravan, crawl boards may be required.
2. There may be wires between the roof and the ceiling. When cutting into the roof, make sure the power is isolated to prevent the risk of electric shock.
3. Installation and maintenance of the air-conditioner must only be performed by personnel with appropriate trade qualifications and holding current licenses for such work.
4. Ensure the air-conditioner has been installed in compliance with the instructions of this manual. Incorrect installation methods or alteration of the product may cause damage to the product or personal injuries to the user.
5. Make sure the external electric supply socket of the caravan air-conditioner is effectively grounded in accordance with appropriate electrical standards. Failure to ground the unit correctly may cause electric shock or fire.
6. Ensure that your electrical supply and wiring is correctly sized for the power and meets appropriate electrical standards.
7. Switch on the power to the air-conditioner at the isolation breaker.
8. The caravan air-conditioner must be switched on for electric leakage detection after installation.
9. Use the remote control to operate the air-conditioner.

# Operation instruction

## Tips (continued)

10. To select the *COOL mode*, adjust the set point temperature to three degrees lower than the room temperature, the unit will start to blow cold air after the compressor starts – approximately 3 minutes.
11. To select the *HEAT mode*, adjust the setting temperature as three degrees higher than the room temperature.
12. If you are not to use the air-conditioner for an extended period, please isolate the power supply.
13. This appliance is not to be used by persons (including children) with reduced physical, sensory or mental capabilities, or lack of experience and knowledge, unless they are under supervision.
14. The system is set automatically to monitor freezing of the evaporator, If this happens the system will automatically start "Defrosting" process. At first it will display "DF" on the display, then the 4-way valve will change its flow direction for 1 minute and compressor will run 10 minutes, until the system detects there is no more frosting on the evaporator. After this process is finished, the "DF" will disappear from the display, and the unit will continue running.

**Note:** After selecting the COOL/HEAT mode, the compressor will have a delay start for three minutes.

# Operation instruction

## Remote control

**Mode Display**  
AUTO/COOL/DRY/FAN/HEAT

**Setting Temperature Display**  
°C/°F

**Room temperature Display**  
°C/°F

**Timer OFF Display**

**Timer ON Display**  
Real Time Clock

**POWER Key**  
Power On and Off

**LED Key**  
Turn On and Turn Off LED

**MODE Key**  
Circular Select AUTO  
/COOL/DRY/FAN/HEAT Mode

**DISPLAY Key**  
Control Plenum Display On and Off

**LOCK Key**  
Spare

**TIME+ Key**

**TIME- Key**

**CLOCK Key**

**°C/°F Key**  
Switch Temperature Between  
Celsius and Fahrenheit

**Fan Speed Display**  
Low/Medium/High/Auto

**Led On/Off Display**

**Clean Filter Function Display**

**Sleep Function Display**

**Up Key (Set Temperature)**

**Down Key (Set Temperature)**

**CANCEL Key**  
Turn Off Clean Filter Display

**FAN Key**  
Circular Select  
Low/Medium/High  
Speed/AUTO

**ON Key**  
Setting Timer Of The  
Unit Turn On

**OFF Key**  
Setting Timer Of The  
Unit Turn Off

**ENTER Key**

**SLEEP Key**  
Only Available In COOL  
And HEAT Modes

**RESET Key**  
Factory Reset



# Operation instruction

## Plenum display



## Operation of the remote control

### TURN ON

Press the "Power  " key, the unit turns on, the buzzer in the plenum beeps one time and the running mode and the temperature will be displayed.



### TURN OFF

Press the "Power  " key again, unit turns off and the plenum will display nothing.

### AUTO mode

Press the "MODE" key, select the " " mode, Fan volume will set automatically, and it is adjustable. Press "FAN" button to get expected volume. Press the up "TEMP+" or down "TEMP-" key to set desired temperature. Depending upon the difference between the set temperature and the ambient temperature the air-conditioner will automatically decide cooling or heating.

### COOL mode



Press the "MODE" key, select the " " mode, and Press the down "TEMP-" key to set the temperature lower than the room temperature. Press the "FAN  " key to select different speed and the plenum will display " " and the set temperature.





# Operation instruction

## Operation of the remote control (continued)



### DEHUMIDIFY mode

Press the “MODE” key, select the “” mode, the air volume is un-adjustable to stay at minimum level. Press the down “TEMP-” key to set the temperature 1°C lower than the room temperature, and the plenum will display “” and the set temperature.

### FAN mode

Press the “MODE” key, select the “” mode, Press the “FAN” key. Select Low/Medium/High/AUTO. The plenum will display “” and the indoor environment temperature.

### HEAT mode

Press the “MODE” key, select the “” mode, Press the up “TEMP+” key to set the temperature higher than the room temperature. Press the “” key to select different speed. And the plenum will display “” and the set temperature.

### Celsius and Fahrenheit degree change

In any mode, press the “°C/°F” key, you can vary temperature between Celsius and Fahrenheit.

### LED turn on and turn off

Press the LED key, the LED light turn on, Press the LED key again, the LED light turn off.

# Operation instruction

## Operation of the remote control (continued)

### TIMER ON

Press the “**TIMER ON**” key, the hour digit will flash. Press “**TIME+**” or “**TIME-**” key to set desired time for “**TIMER ON**”. Press the “**OK**” key to confirm setup is done.

### TIMER OFF

Press the “**TIMER OFF**” key, the hour digit will flash. Press “**TIME+**” or “**TIME-**” key to set desired time for “**TIMER OFF**”. Press the “**OK**” key to confirm setup is done.

### CLOCK set

Press “**CLOCK**” button to set the time: keep in pressing “**TIME+**” or “**TIME-**” key to select a desired time

### SLEEP

Press the “**SLEEP**” key to display sleep icon on the remote screen, under this function the temperature after 1 hour will automatically increase 1 degree, and after 2 hours it will raise 2 degrees, then it will maintain the same temperature until it automatically turns off 8 hours after setting.

In contrast, in heating mode will automatically reduce 1 degree and reduce 2 degrees after 2 hours, then it will maintain the same temperature until it automatically turns off 8 hours after setting.

# Operation instruction

- THE REMOTE CONTROL WILL ONLY OPERATE IF DIRECTLY POINTED AT THE PLENUM. It will beep once when the signal is received. Adjust the distance and angle if the plenum does not respond.
- The unit will blow cold air in COOL mode and hot air in HEAT mode.
- When the unit is on, press the “DISPLAY” key on the remote control to display on the plenum.
- The air-conditioner features power cut memory and automatic resets after restarting.
- Low temperature heating will cause frosting, during which it is normal to show “DF” on the plenum.
- When the outside temperature is lower than 0 degrees, the heating effect is reduced. Adopt alternative methods of heating.
- If the device is to be left unused for an extended period, remove the batteries from the remote control.

# Specification parameters

## Specification parameters

Model	Jupitair 2400-50
Power supply	220~240V/50Hz
Refrigerant charged	R407C/450g
Rated cooling capacity (W)	2400
Rated heating capacity (W)	2400
Input power for cooling (W)	940
Input power for heating (W)	850
Rated current for cooling (A)	4.1
Rated current for heating (A)	3.7
Maximum input power (W)	1170
Maximum current (A)	5.1
Maximum design pressure (kPa)	2900
Minimum design pressure (kPa)	1840
Maximum air flow (l/s)	102
Installed weight (kg)	33
Minimum ambient temperature (°C) -heating	-5
Maximum ambient temperature (°C) -cooling	55
Main unit dimension	Height 244mm Width 567mm Length1079 mm
Plenum unit dimension	Height 40mm Width 540mm Length 536mm

**Note:**

1. All parameters listed are subject to change without notice and the nameplates on the machine shall prevail;
2. E&OE All values are approximate & subject to change.

# Product maintenance

## Filter

- The air filters are the only components needing to be maintained periodically.
- Check and clean the filters each week when in use. The system will remind you to clean filters after 500h compressor time, it will show on the display. 
- a). Remove the filters from the plenum and wash in warm water with a touch of detergent.
- b). Click the cancel button for 3 seconds to reset the display indicator.

## Screw check

- It is recommended that the bolts holding the unit to the roof are checked for tightness 3 months after the first installation of the product.
- These bolts should be regularly inspected a minimum of every 12 months through- out the air conditioners life.

## Maintenance

- It is recommended that the air-conditioner is operated regularly to ensure good performance.
- In the case of a caravan that will not be used regularly then the unit should be operated for 20-30 minutes every 6 months.
- In the event the caravan is parked outdoors for an extended period it is recommended a protective jacket be fitted over the main unit of the air conditioner to protect from the elements.

# Troubleshooting guide

## 1. Display not showing on the plenum when turned on /off

- Check if the power is connected properly to RV.
- Check if the battery of remote control is good.
- Check if the remote control is turned on off.
- Check if the power has good connection from roof unit to plenum.

## 2. Cooling not good

- Select correct cooling mode and confirm light  is showing.
- The set temperature should be lower than room temperature.
- There is three minutes delay on compressor.
- Make sure filters are clean.
- Select max fan to achieve best performance.

- Be sure all door and windows are closed.
- Draw curtains to help reduce incoming heat.

## 3. Heating not good

- Select correct heating mode and confirm light  is showing.
- The set temperature should be higher than room temperature.
- There is three minutes delay on compressor.
- It needs more time to start heating on an extremely cold winter day.
- Make sure filters are clean.
- Select max fan to achieve best performance.
- Be sure all door and windows closed  
Curtains should help to introduce cold air in.

E0	<b>Communication fault</b>
Fault in connection to temperature sensor or other damage.	
E1	<b>Room temperature sensor</b>
Fault in connection to temperature sensor or other damage.	
E2	<b>Indoor coil temperature sensor</b>
Fault in connection to temperature sensor or other damage.	
E3	<b>Outdoor coil temperature sensor</b>
Fault in connection to temperature sensor or other damage.	
E4	<b>Insufficient refrigerant</b>
Capillary tube fracture leads to coolants leakage, compressor fault or sensor failure.	
E5	<b>Temperature anomaly-outdoor coil</b>
Temperature too high when cooling or too low when heating. (When cooling, the display of E5 indicates the outdoor temperature exceeds 65°C. It is likely due to the reduction of air flow of the condenser, poor working of condenser fan or sensor failure; when heating, if the outdoor temperature is higher than 18°C, the external air blower may rotate between on and off. The occurrence of this is not a fault, but the self-protection of the system for avoiding overheating of the unit.)	

# Warranty

The unit comes with a 2-year warranty for parts only.

The unit should be serviced by a skilled air-conditioner dealer or service center.

The warranty is only applicable if:

1. The unit has been subject to what can be described as “normal use”.
2. The unit has been cleaned, serviced and maintained after “normal use” standards.
3. The unit has been correctly installed according to the installation manual.
4. The unit has not been damaged or exposed to any abnormal use.
5. The unit is installed in a unit for leisure purpose.

Recommended service after 1 year and every following 2 years:

- a. Remove top cover and clean for any dirt and dust.
- b. Check the fan and compressor is running normally.
- c. Check for any leakage
- d. Check cables
- e. Remove the inside plenum and tighten the 4 mounting screws to correct torque (12 to 14 Nm).
- f. Check plenum cables and power supply.
- g. Run the unit for 20 minutes in cooling mode and then on heating mode to check for any abnormal noise or functionality.





# Service Book

Service after 1 year from its first installation date.

Date (dd.mm.yyyy): \_\_\_\_\_

Appointed Service center: \_\_\_\_\_

Stamp and signature: \_\_\_\_\_

Name of person signing  
on behalf of the Service \_\_\_\_\_

Centre: (please print)

Service after 3 years from its first installation date.

Date (dd.mm.yyyy): \_\_\_\_\_

Appointed Service center: \_\_\_\_\_

Stamp and signature: \_\_\_\_\_

Name of person signing  
on behalf of the Service \_\_\_\_\_

Centre: (please print)

Airva SARL

10 avenue du Fief

BP 89162 Saint Ouen l Aumone

95310 CERGY PONTOISE cedex

France

Web: [www.airva.eu](http://www.airva.eu)

Email: [info@airva.eu](mailto:info@airva.eu)